



Cel VALENÇA
C Dout Ex

EXPERIMENTAÇÃO DOUTRINÁRIA
COMPANHIA DE ASSUNTOS CIVIS

SUMÁRIO

1

Introdução (Doutrina do EB)

2

DOPEMAII

3

Experimentação Doutrinária



Hard Power

- *Atores estatais*
- *Poderio bélico e econômico*



Soft Power

- *Atores estatais e não estatais*
- *Aspectos ideológicos, sociais e culturais*

GRAZIE

SOLDATO



CAPÍTULO 2 - BRINCANDO COM PRACINHAS











ASSUNTOS CIVIS - NOMENCLATURA



Civil Affairs (CA)

Civil-Military Cooperation (CIMIC)

Civil-Military Coordination (CIMIC)

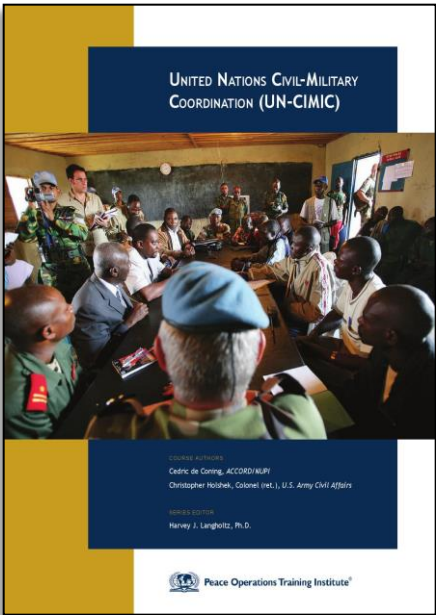
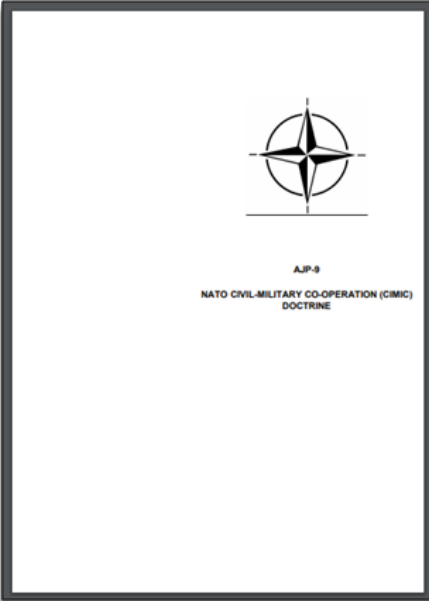

DOCTRINA



Nível Operacional

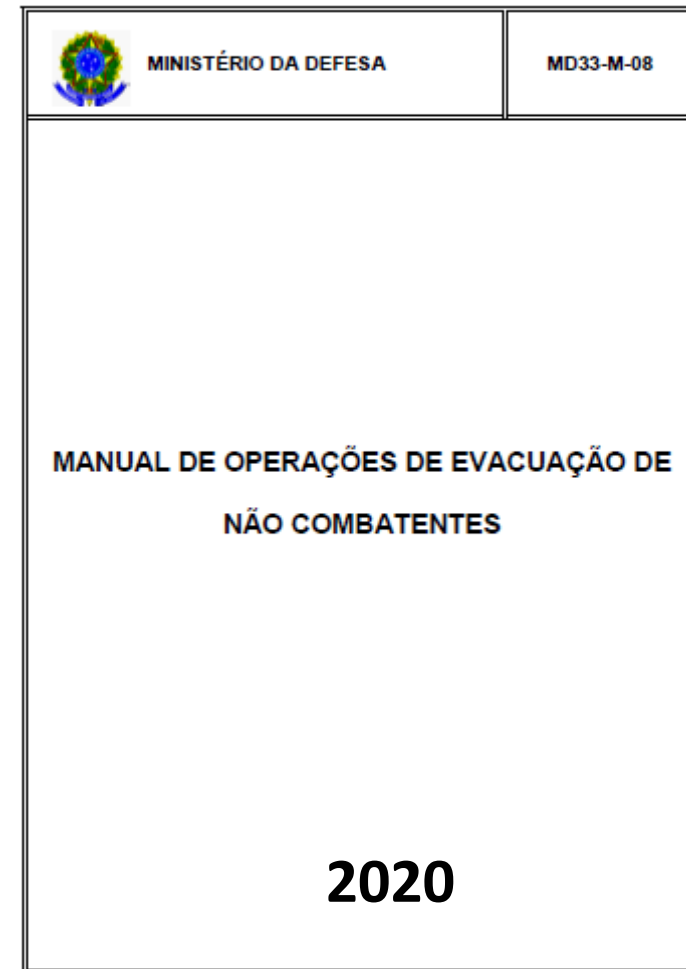
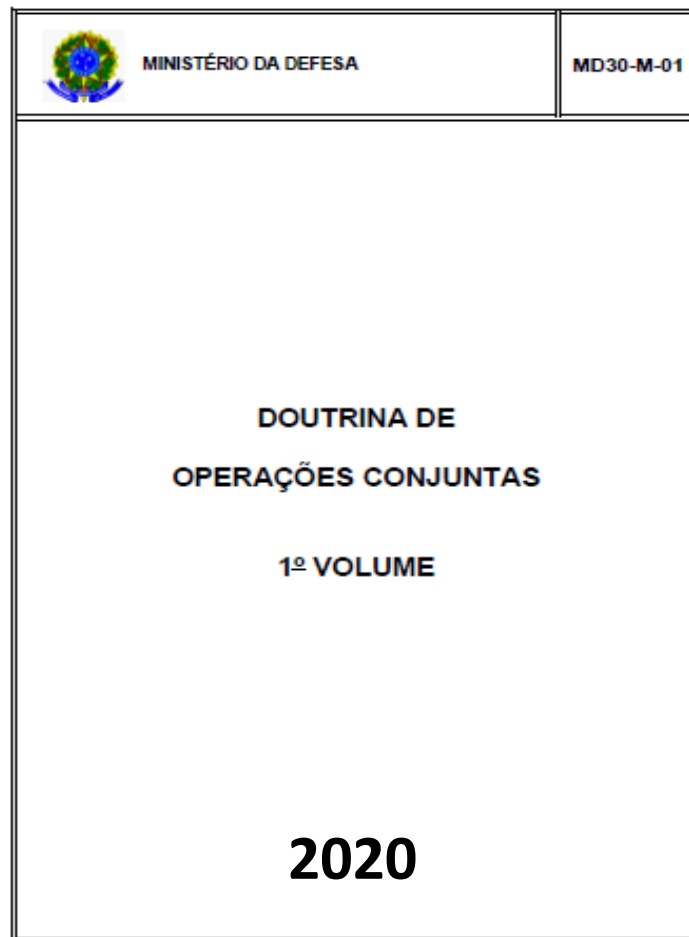

DOCTRINA



Nível Tático

EB20-MC-10.201



C 41-6

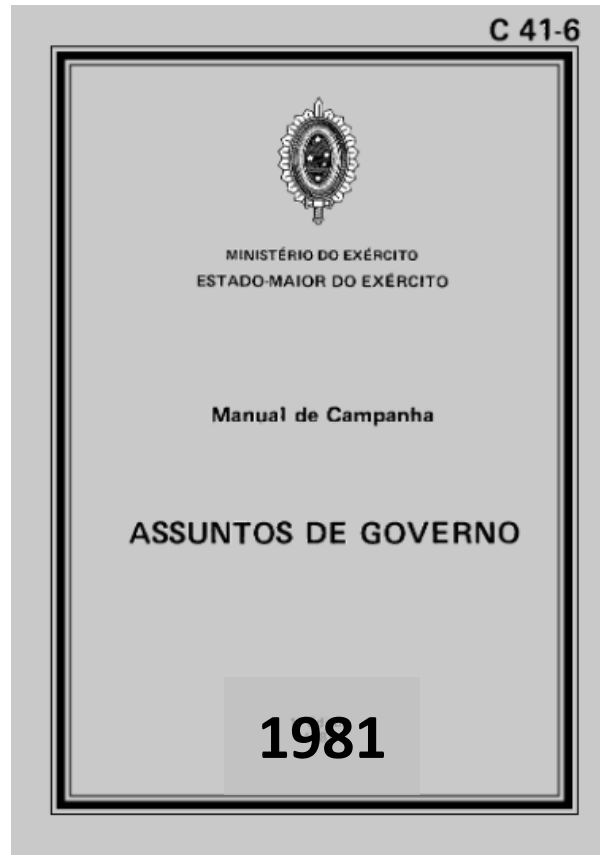

EB70-MC-10.221





Assuntos Cívicos

Assuntos de Governo

- Coordenação com OG
- Atv governamentais, económicas, de serviços públicos e especiais

Cooperação Civil-Militar (CIMIC)

- Coordenação com OI, ONG, OP e população
- Ação comunitária

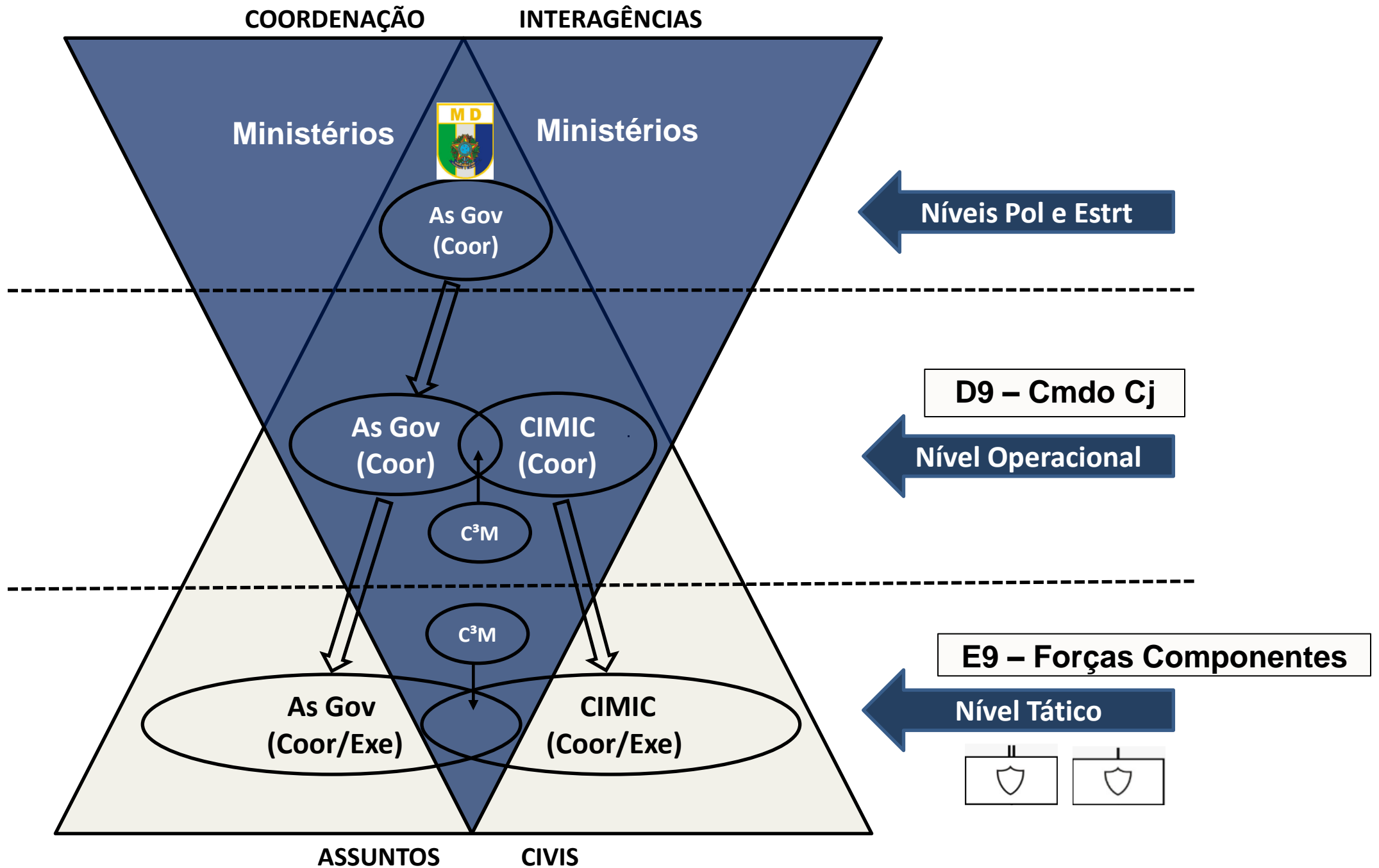



Intensidade das ações de As Civ - Estimativa

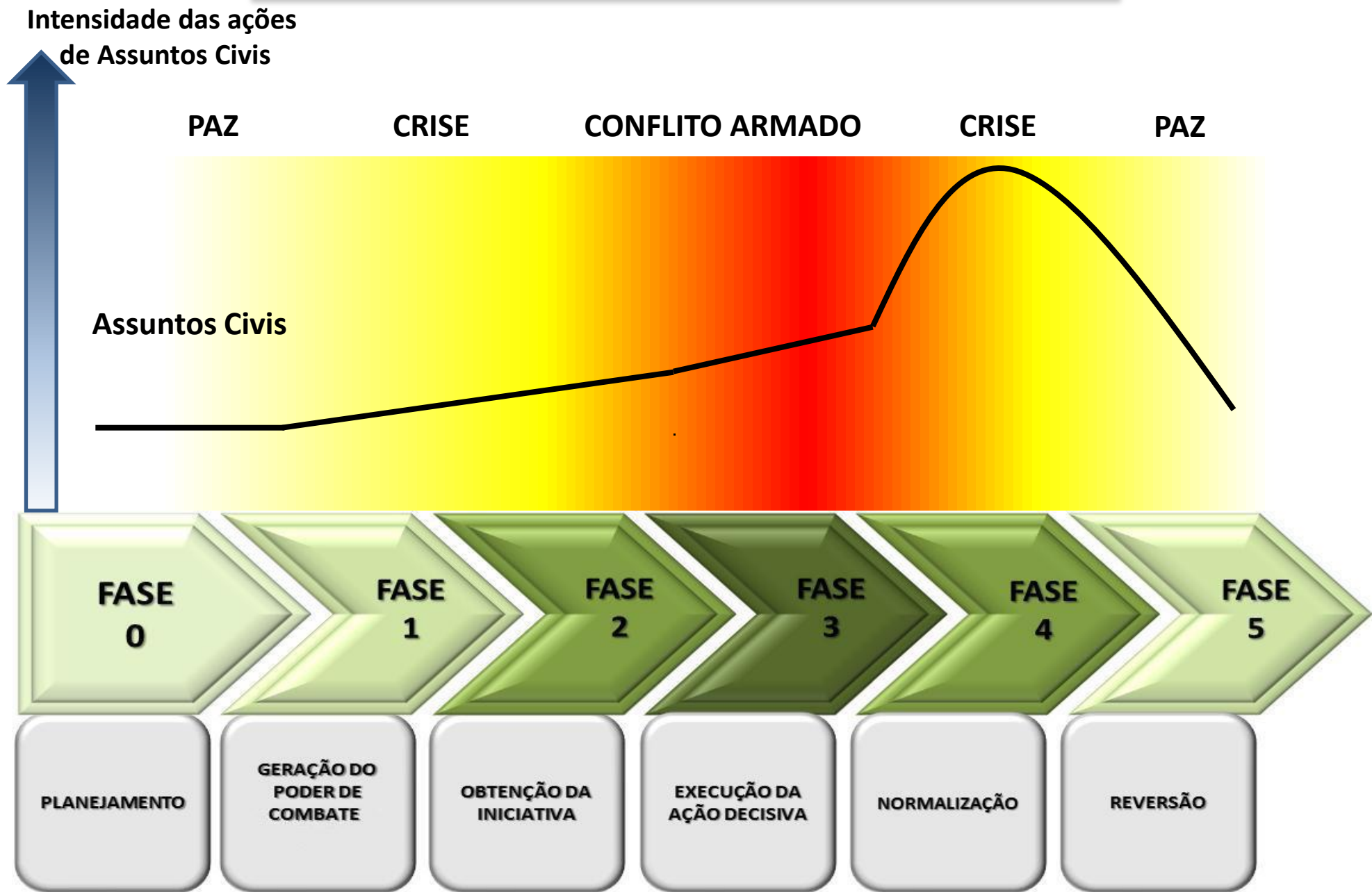



Assuntos Cívicos e as Operações de Informação

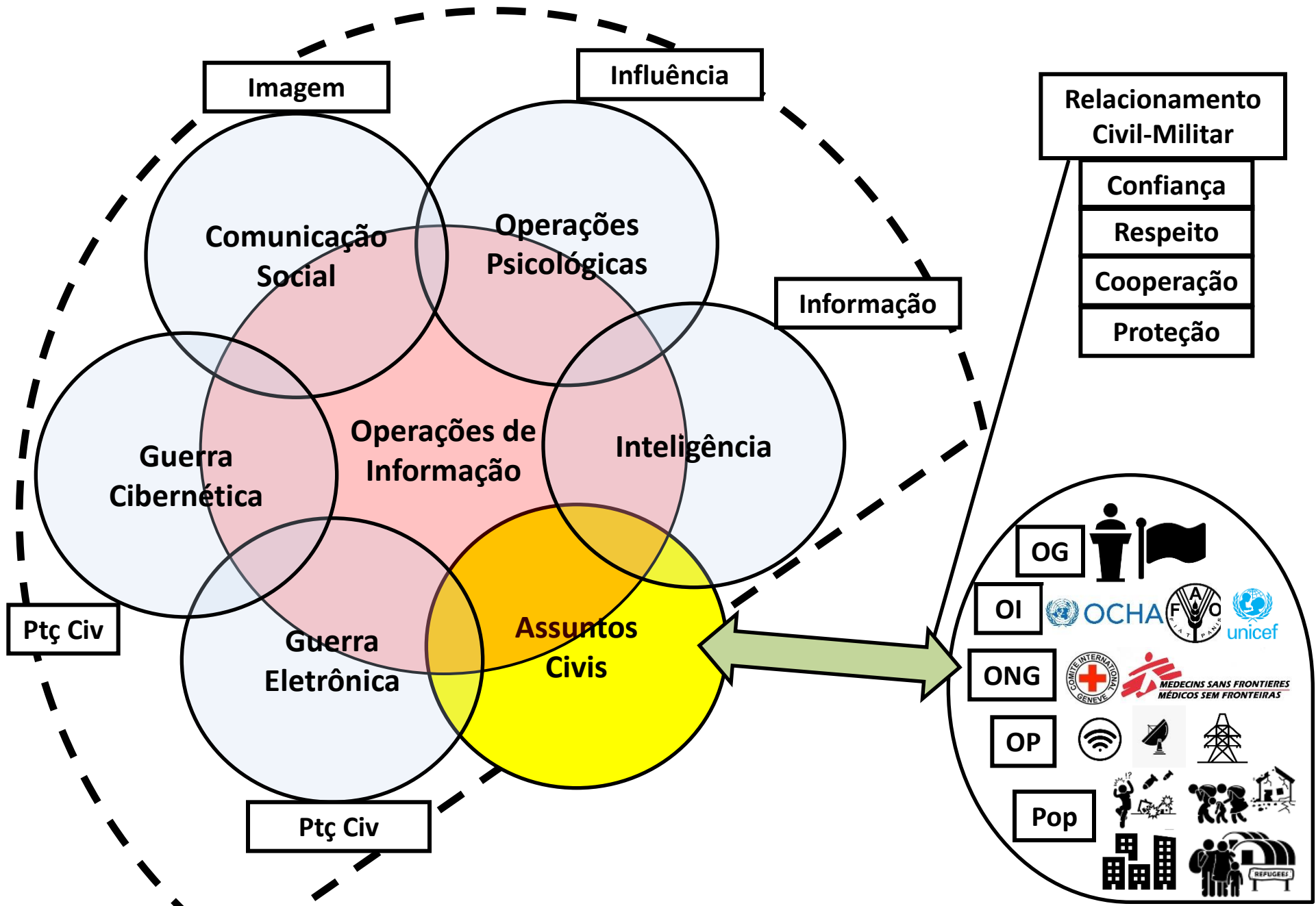

SUMÁRIO

1

Introdução (Doutrina do EB)

2

DOPEMAII















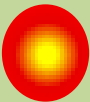

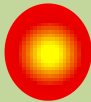

3

Experimentação Doutrinária







Análise – Assuntos Cíveis

	FATORES / CAPACIDADE							
	D	O	P	E	M	A	I	I
Assuntos Cíveis 								
Assuntos Cíveis 								

Legenda

-  80 a 100%
-  50 a 80%
-  Abaixo de 50%





DOCTRINA – As Civ

COMO COMBATER?

COMO ORGANIZAR?

COMO EQUIPAR?

**Base Doutrinária +
Manual de Campanha**

**Estrutura
Organizacional e QC**

QDM



PLANEJAMENTO BASEADO EM CAPACIDADES (PBC)

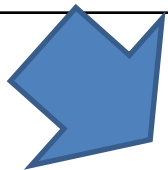

CAPACIDADE MILITAR TERRESTRE (CMT)

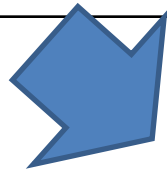

CAPACIDADES OPERATIVAS



DOPEMA II



**ATIVIDADES
- Tarefas**

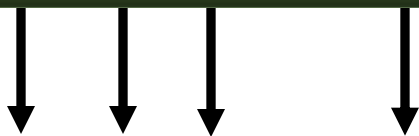

QO





Assuntos Civis

(árvore de manuais)

2º Nível

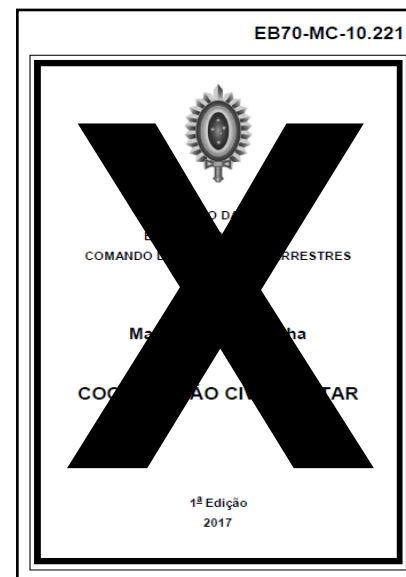
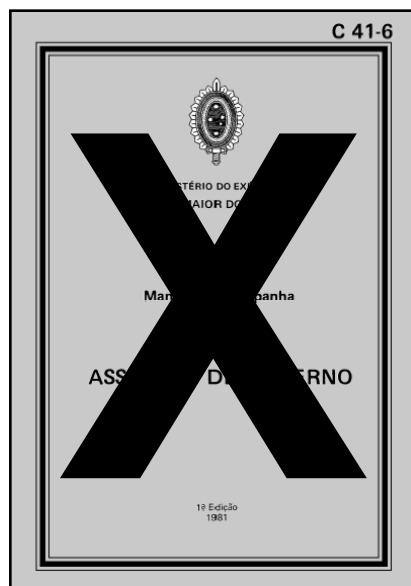

3º Nível

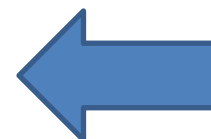

Expr Dout

SUMÁRIO

1

Introdução (Doutrina do EB)

2

DOPEMAII

3

Experimentação Doutrinária



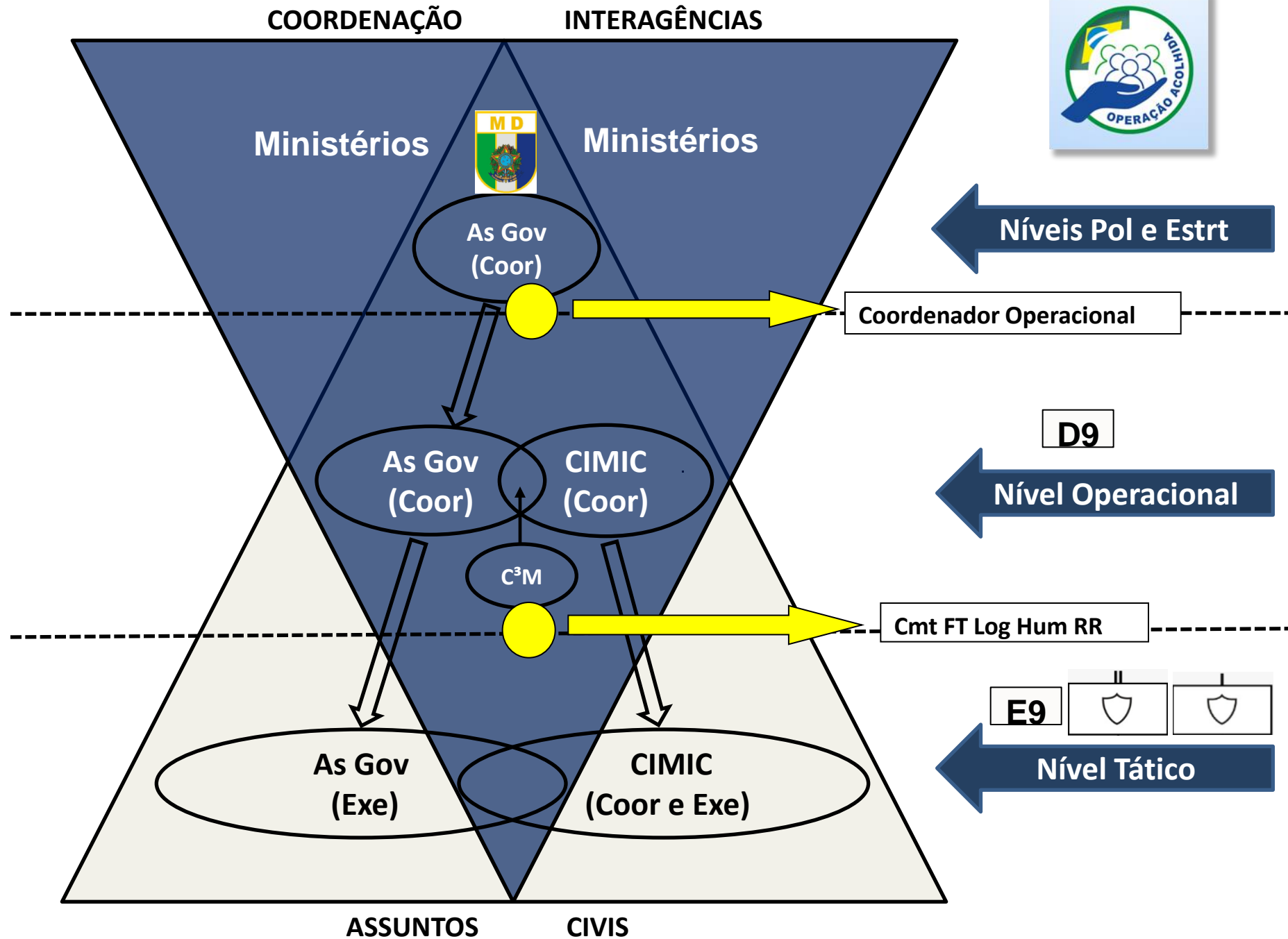

Doutrina – As Civ

PAÍS VERMELHO

PAÍS AZUL

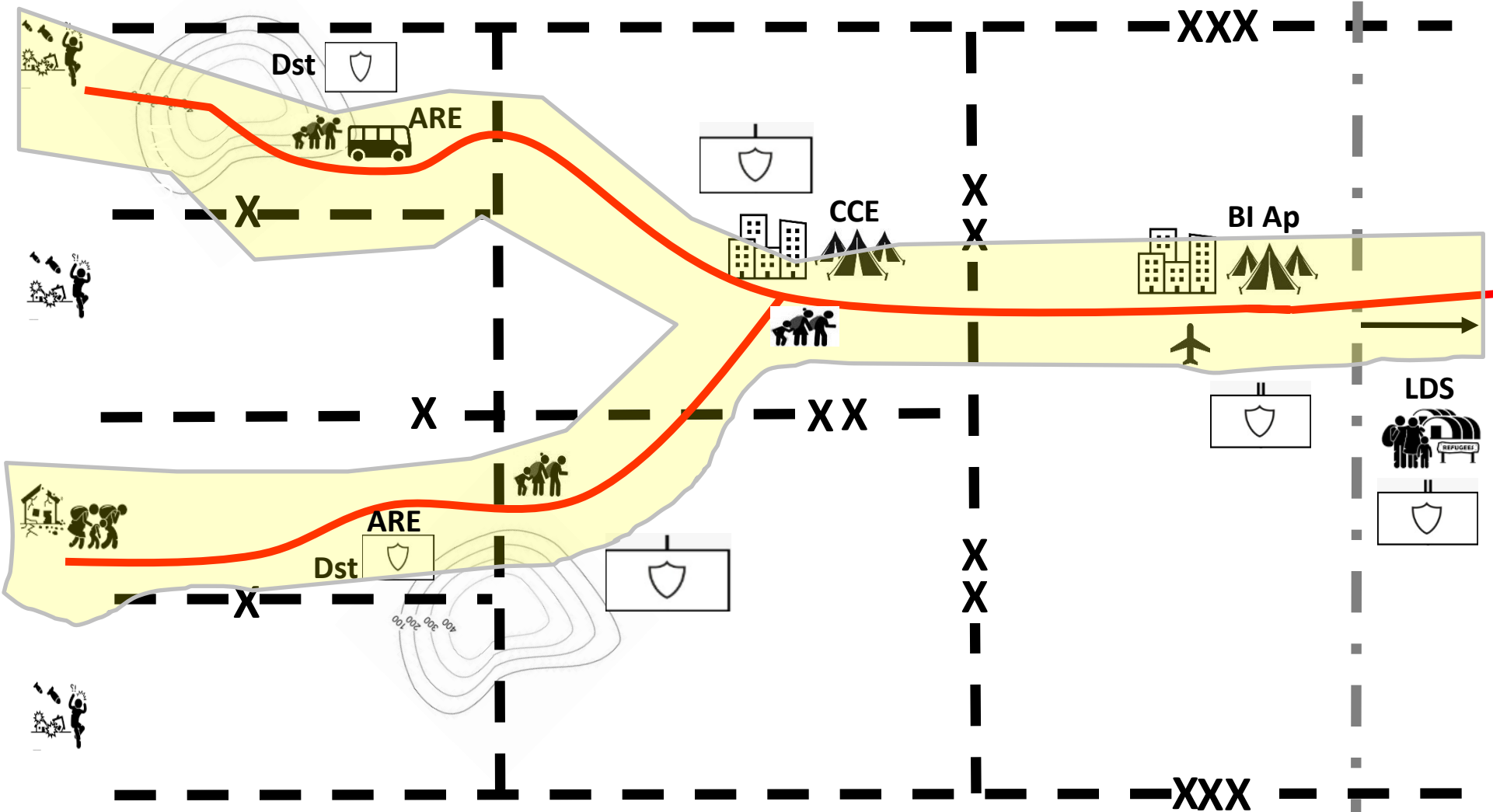

– Corredor Humanitário

CCE – Centro de Controle de Evacuados

ARE – Área de Reunião de Evacuados

BI Ap – Base Intermediária de Apoio

LDS – Local de Destino Seguro

Experimentação Doutrinária – Cia As Civ

ARE/CCE

PRI / PI Trg/Abrigos (2)

PACARAIMA

CCE/BI Ap

CCE/BI Ap

PI Trg/Abrigos (11)

PI Trg/Abrigo

BOA VISTA

MANAUS

LDS



 – Corredor Humanitário PRI – Posto de Recepção e Identificação PI Trg – Posto de Interiorização e Triagem

ARE – Área de Reunião de Evacuados BI Ap – Base Intermediária de Apoio LDS – Local de Destino Seguro

Cronograma

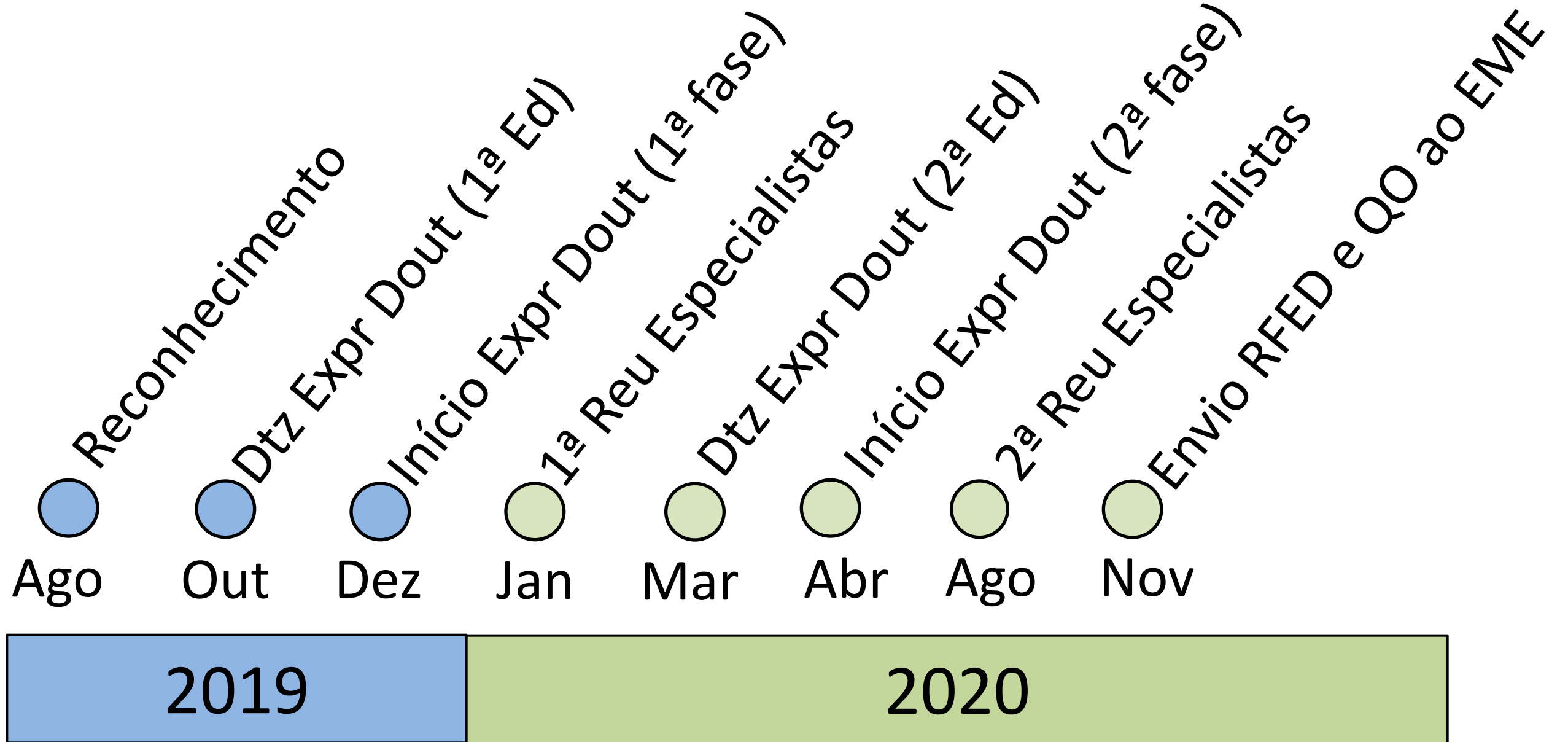

Expr Dout Cia As Civ

Estrutura Organizacional

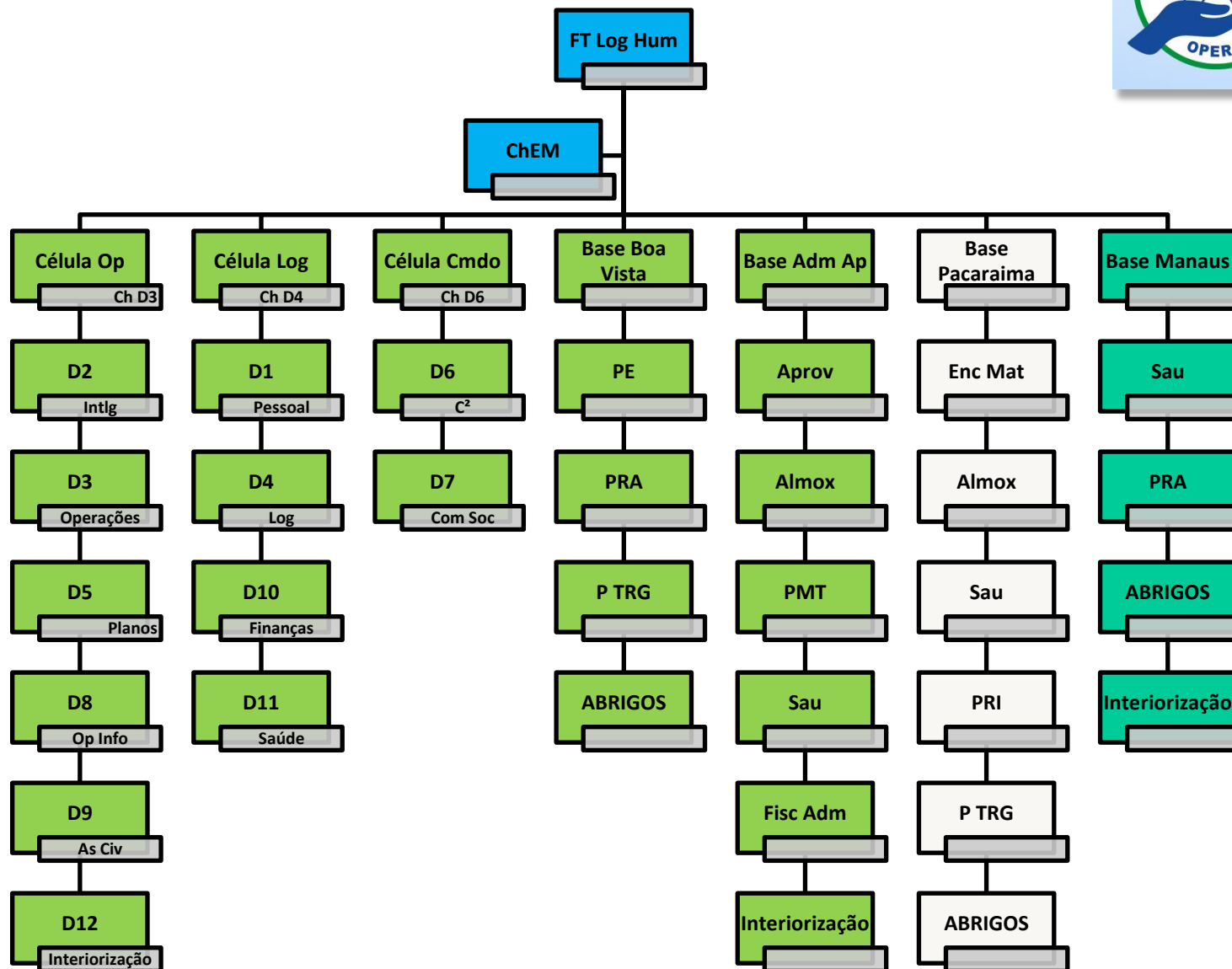

Expr Dout Cia As Civ

Estrutura Organizacional

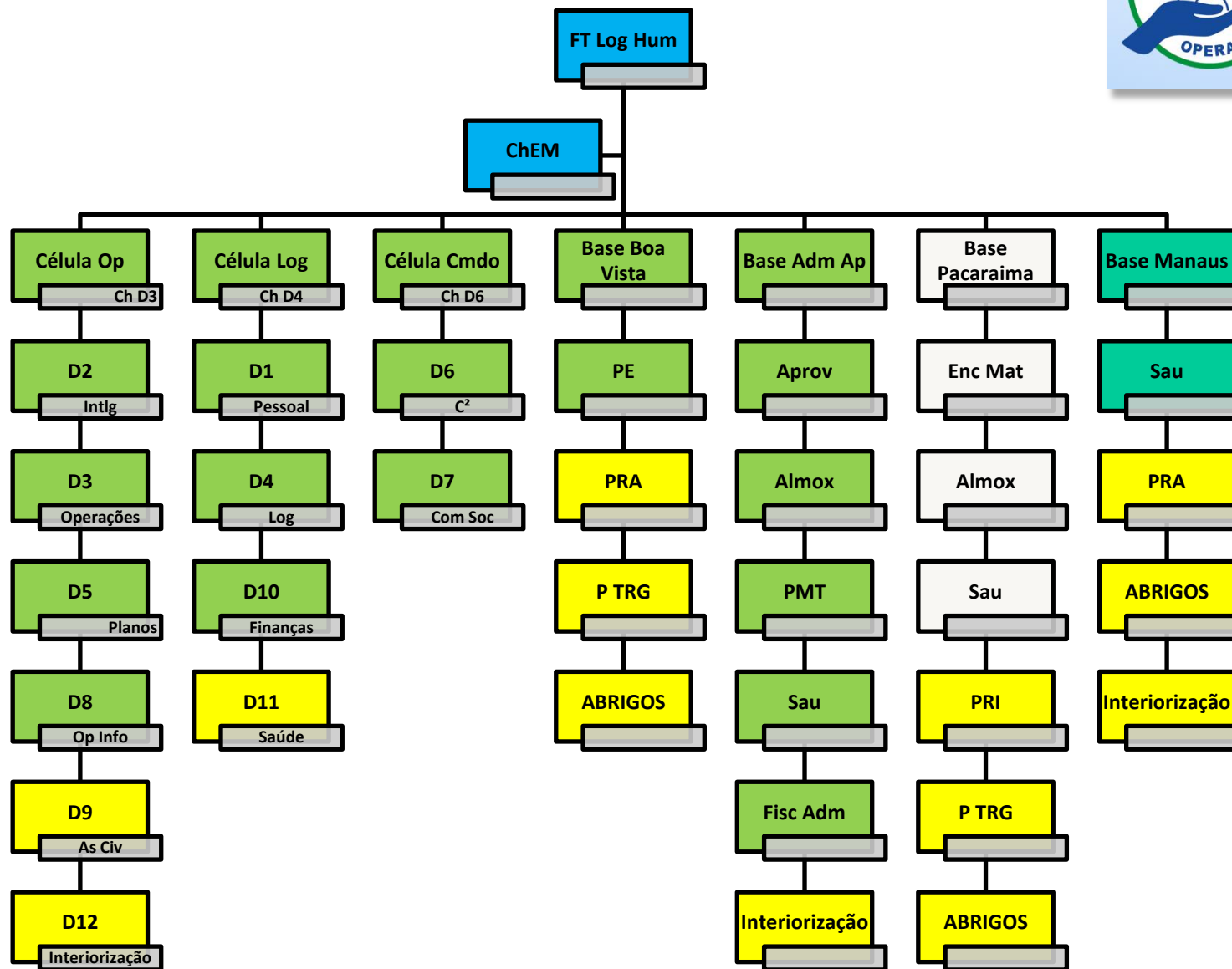

Expr Dout Cia As Civ

Estrutura Organizacional

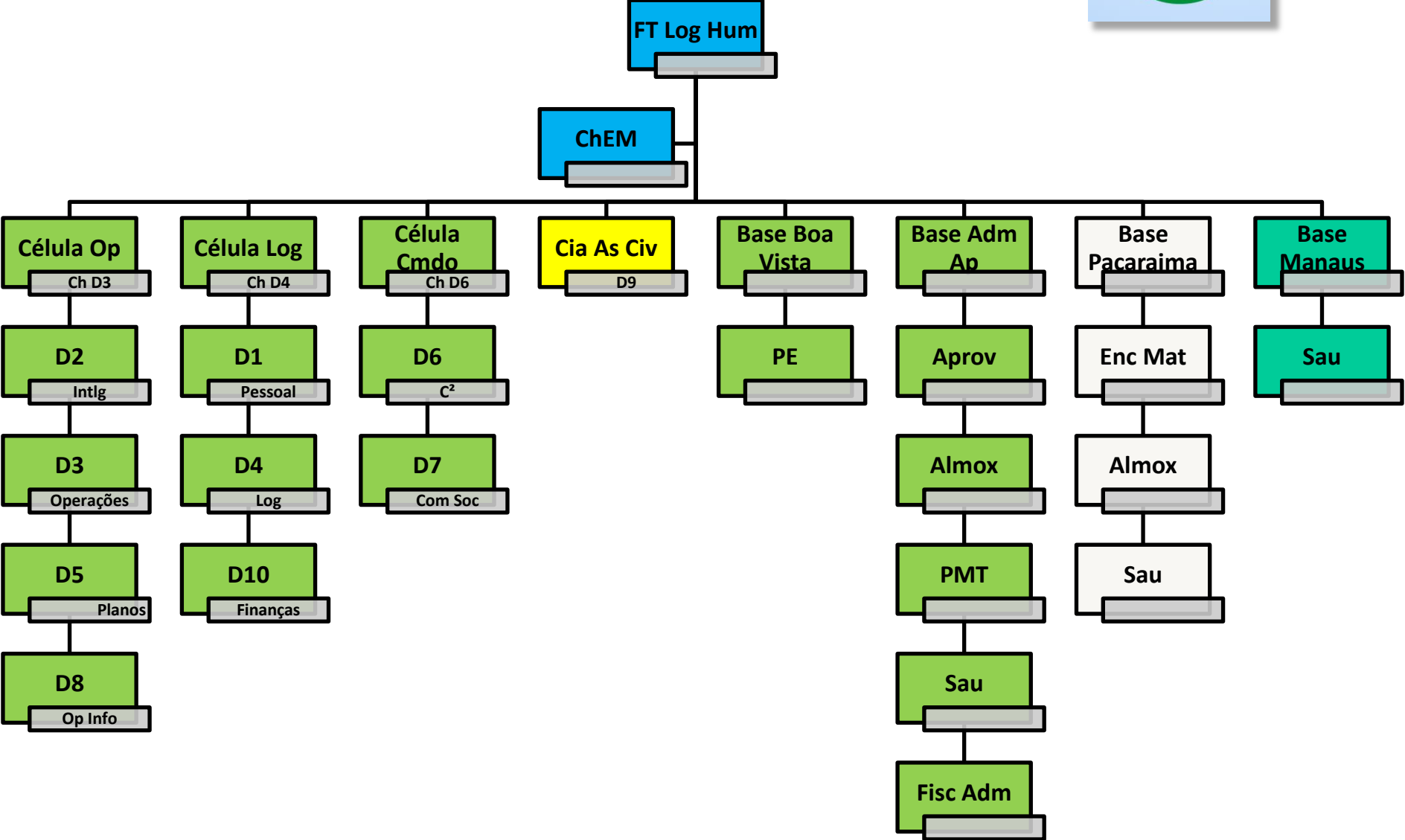

Estrutura Organizacional – Cia As Civ (Dtz Expr Dout – 1ª Edição)

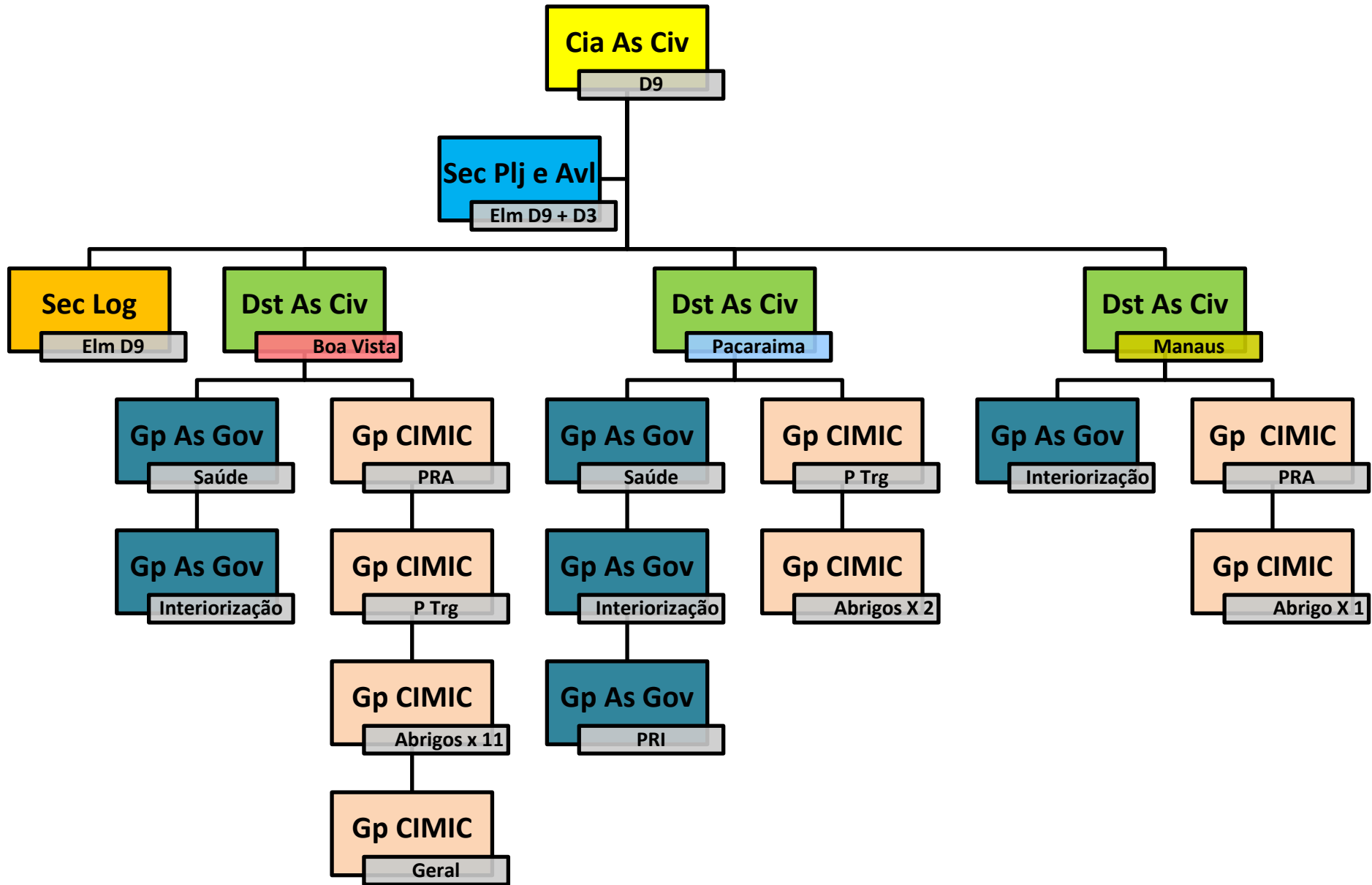

Estrutura Organizacional – Cia As Civ (Dtz Expr Dout – 2ª Edição)

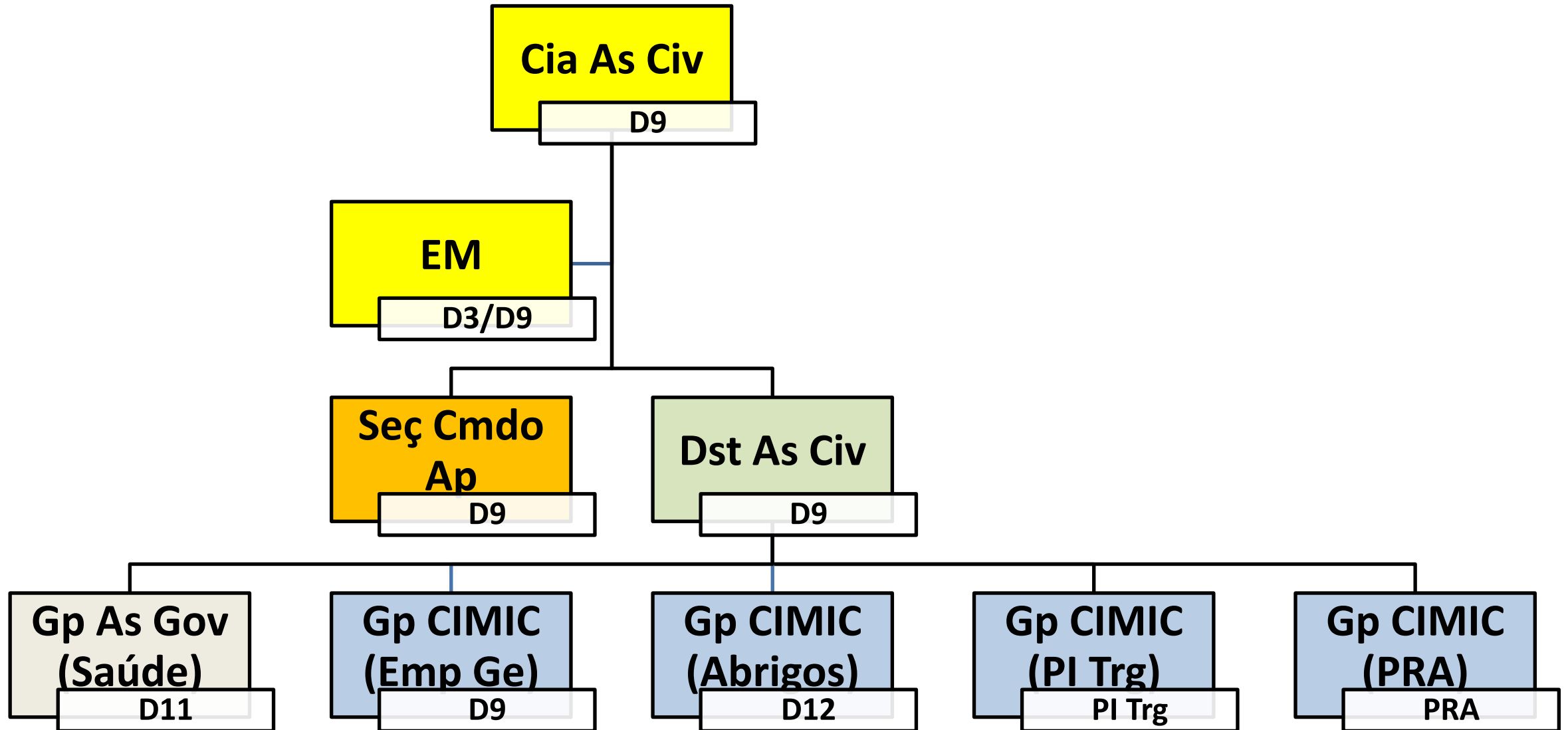



QUADRO DE ORGANIZAÇÃO (QO)

BASE DOUTRINÁRIA

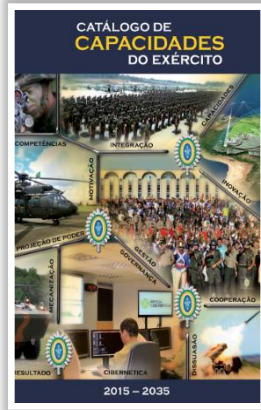

ESTRUTURA ORGANIZACIONAL

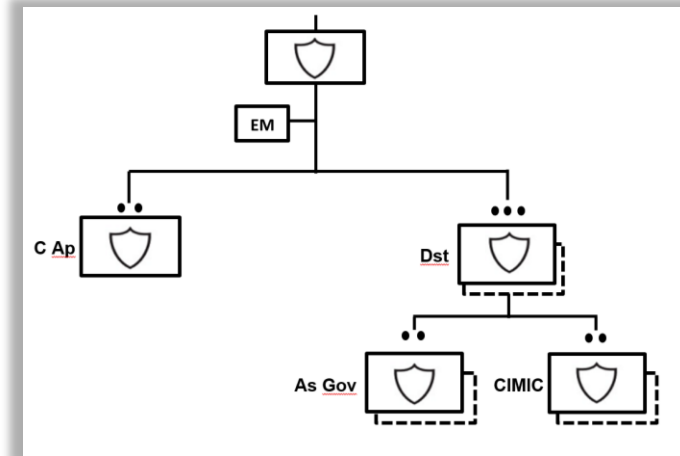

QC

QDM

MATERIAL DE ACESSO RESTRITO
Art. 44 e 45 do Decreto 7.845/2012 de 14 de novembro de 2012

QUADRO DE CARGOS - QC

Elaborado: _____

OM: _____ QC: 0219.30.0

REGIMENTO DE CAVALARIA MECANIZADO

CHEFE CDOUTEX

DISCRIMINAÇÃO DO CARGO	OCUPANTE	CARGOS		OBS	REFERENCIAÇÃO		
		EFETIVO	EFET/M		POSTO GRAD	ARMADO SV-QM	HABILITAÇÕES
2.8.3.1 Comando							
Comandante	2º Sgt	1	2	2608	23	5202	000 000
2.8.3.2 1ª Peça de Morteiro Pesado							
Chefe da Peça		(1)	(2)				
Atrador	Cb	1	2	42	0201	000 000	
Motorista VBMT-MSR	Cb	1	2	4812	0201	751 000	
Auxiliar de Atrador	Sd	1	2	44	0201	927 000	
Muniçador	Sd	1	2	126	44	0201	993 000
2.8.3.3 2ª Peça de Morteiro Pesado							
Chefe da Peça	3º Sgt	1	2	24	5202	000 000	
Atrador	Cb	1	2	42	0201	000 000	
Motorista	Cb	1	2	4812	0201	751 000	
Auxiliar de Atrador	Sd	1	2	12P	44	0201	927 000
Muniçador	Sd	1	2	12G	44	0201	993 000
3 ESQUADRÃO DE CAVALARIA MECANIZADO(S)							
3.1 Comando							
Comandante	Cap	1	3	16	8102	050 000	
Subcomandante	1º Ten	1	3	16	8102	000 000	
3.2 Seção de Comando							
3.2.1 Chefia							
Encarregado de Material	S Ten	1	3	21	5202	000 000	

MATERIAL DE ACESSO RESTRITO
Art. 44 e 45 do Decreto 7.845/2012 de 14 de novembro de 2012

PLANO DE EQUIPAMENTOS ESPECÍFICOS REGIMENTO DE CAVALARIA MECANIZADO

1. COMANDO E ESTADO-MAIOR
Os Órgãos estão incluídos nos grupos específicos.

2. ESQUADRÃO DE COMANDO E APOIO
2.1 Seção de Comando

FRACAO	VIATURA	ARMAMENTO	OUTROS	OBS
2.1.2 Grupo de Comando				
2.1.2.1 Turno de Comando	V01 - VTN8 404 % Tee - 02			Com 2º Sgt C Ap Subcomandante 2º Sgt C Ap
2.1.2 Grupo de Pessoal				
2.1.2.1 Turno de Pessoal	V01 - VTN8 404 % Tee - 01 V36 - V36Z 2K % Tee - 03	A11 - M4 P - 01 A17 - R47 Ter M4 P - 01 Q24 - 24 P404 00P	Q01 - Compt Cap - 01 Q02 - Q02 - 01 SRTA - 01	Sgts
2.1.3 Grupo de Suprimento				
2.1.3.1 Turno de Suprimento	V02 - VTN8 404 % Tee - 01 V03 - V36Z 2K % Tee - 01 V04 - V36Z 2K % Tee - 01			Esc Mat
2.1.3 Grupo de Logística				
2.1.3.1 Turno de Logística	V01 - VTN8 404 % Tee - 01 V36 - V36Z 2K % Tee - 01	A11 - M4 P - 01 A17 - R47 Ter M4 P - 01		
2.1.3.2 Turno de Manutenção				
2.1.3.2.1 Turno de Manutenção	V01 - VTN8 404 % Tee - 01 V36 - V36Z 2K % Tee - 01			
2.1.3.2.2 Turno de Manutenção				
2.1.3.2.2.1 Turno de Manutenção				
2.1.3.2.2.2 Turno de Manutenção				
2.1.3.2.2.3 Turno de Manutenção				
2.1.3.2.2.4 Turno de Manutenção				
2.1.3.2.2.5 Turno de Manutenção				
2.1.3.2.2.6 Turno de Manutenção				
2.1.3.2.2.7 Turno de Manutenção				
2.1.3.2.2.8 Turno de Manutenção				
2.1.3.2.2.9 Turno de Manutenção				
2.1.3.2.2.10 Turno de Manutenção				
2.1.3.2.2.11 Turno de Manutenção				
2.1.3.2.2.12 Turno de Manutenção				
2.1.3.2.2.13 Turno de Manutenção				
2.1.3.2.2.14 Turno de Manutenção				
2.1.3.2.2.15 Turno de Manutenção				
2.1.3.2.2.16 Turno de Manutenção				
2.1.3.2.2.17 Turno de Manutenção				
2.1.3.2.2.18 Turno de Manutenção				
2.1.3.2.2.19 Turno de Manutenção				
2.1.3.2.2.20 Turno de Manutenção				
2.1.3.2.2.21 Turno de Manutenção				
2.1.3.2.2.22 Turno de Manutenção				
2.1.3.2.2.23 Turno de Manutenção				
2.1.3.2.2.24 Turno de Manutenção				
2.1.3.2.2.25 Turno de Manutenção				
2.1.3.2.2.26 Turno de Manutenção				
2.1.3.2.2.27 Turno de Manutenção				
2.1.3.2.2.28 Turno de Manutenção				
2.1.3.2.2.29 Turno de Manutenção				
2.1.3.2.2.30 Turno de Manutenção				
2.1.3.2.2.31 Turno de Manutenção				
2.1.3.2.2.32 Turno de Manutenção				
2.1.3.2.2.33 Turno de Manutenção				
2.1.3.2.2.34 Turno de Manutenção				
2.1.3.2.2.35 Turno de Manutenção				
2.1.3.2.2.36 Turno de Manutenção				
2.1.3.2.2.37 Turno de Manutenção				
2.1.3.2.2.38 Turno de Manutenção				
2.1.3.2.2.39 Turno de Manutenção				
2.1.3.2.2.40 Turno de Manutenção				
2.1.3.2.2.41 Turno de Manutenção				
2.1.3.2.2.42 Turno de Manutenção				
2.1.3.2.2.43 Turno de Manutenção				
2.1.3.2.2.44 Turno de Manutenção				
2.1.3.2.2.45 Turno de Manutenção				
2.1.3.2.2.46 Turno de Manutenção				
2.1.3.2.2.47 Turno de Manutenção				
2.1.3.2.2.48 Turno de Manutenção				
2.1.3.2.2.49 Turno de Manutenção				
2.1.3.2.2.50 Turno de Manutenção				
2.1.3.2.2.51 Turno de Manutenção				
2.1.3.2.2.52 Turno de Manutenção				
2.1.3.2.2.53 Turno de Manutenção				
2.1.3.2.2.54 Turno de Manutenção				
2.1.3.2.2.55 Turno de Manutenção				
2.1.3.2.2.56 Turno de Manutenção				
2.1.3.2.2.57 Turno de Manutenção				
2.1.3.2.2.58 Turno de Manutenção				
2.1.3.2.2.59 Turno de Manutenção				
2.1.3.2.2.60 Turno de Manutenção				
2.1.3.2.2.61 Turno de Manutenção				
2.1.3.2.2.62 Turno de Manutenção				
2.1.3.2.2.63 Turno de Manutenção				
2.1.3.2.2.64 Turno de Manutenção				
2.1.3.2.2.65 Turno de Manutenção				
2.1.3.2.2.66 Turno de Manutenção				
2.1.3.2.2.67 Turno de Manutenção				
2.1.3.2.2.68 Turno de Manutenção				
2.1.3.2.2.69 Turno de Manutenção				
2.1.3.2.2.70 Turno de Manutenção				
2.1.3.2.2.71 Turno de Manutenção				
2.1.3.2.2.72 Turno de Manutenção				
2.1.3.2.2.73 Turno de Manutenção				
2.1.3.2.2.74 Turno de Manutenção				
2.1.3.2.2.75 Turno de Manutenção				
2.1.3.2.2.76 Turno de Manutenção				
2.1.3.2.2.77 Turno de Manutenção				
2.1.3.2.2.78 Turno de Manutenção				
2.1.3.2.2.79 Turno de Manutenção				
2.1.3.2.2.80 Turno de Manutenção				
2.1.3.2.2.81 Turno de Manutenção				
2.1.3.2.2.82 Turno de Manutenção				
2.1.3.2.2.83 Turno de Manutenção				
2.1.3.2.2.84 Turno de Manutenção				
2.1.3.2.2.85 Turno de Manutenção				
2.1.3.2.2.86 Turno de Manutenção				
2.1.3.2.2.87 Turno de Manutenção				
2.1.3.2.2.88 Turno de Manutenção				
2.1.3.2.2.89 Turno de Manutenção				
2.1.3.2.2.90 Turno de Manutenção				
2.1.3.2.2.91 Turno de Manutenção				
2.1.3.2.2.92 Turno de Manutenção				
2.1.3.2.2.93 Turno de Manutenção				
2.1.3.2.2.94 Turno de Manutenção				
2.1.3.2.2.95 Turno de Manutenção				
2.1.3.2.2.96 Turno de Manutenção				
2.1.3.2.2.97 Turno de Manutenção				
2.1.3.2.2.98 Turno de Manutenção				
2.1.3.2.2.99 Turno de Manutenção				
2.1.3.2.2.100 Turno de Manutenção				

MATERIAL DE ACESSO RESTRITO
Art. 44 e 45 do Decreto 7.845/2012 de 14 de novembro de 2012

QUADRO DE DOTAÇÃO DE MATERIAL

COM: _____ COM - Nr Cit: _____ Assunto: _____

BATALHÃO DE INTELIGÊNCIA MILITAR 1504.00.0 1

Adoção: Part No (paral) / (paral) / Publicação (paral) / (paral) (SEPARATA)

DOTAÇÃO POR FRACAO				
COODOT	Descrição	Qtd	Obs	N Dot
1. COMANDO E ESTADO-MAIOR				
1.1 Comando				
Classe 2				
Intendência				
Família 1				
Equipamentos				
100100002	Compasso	1		942
100100004	Compasso	1		944
100100013	Compasso	1		1062
100100014	Compasso	1		94
100100015	Compasso	1		63
100100016	Compasso	1		24
100100017	Compasso	1		942
100100018	Compasso	1		1064
100100019	Compasso	1		491
100100020	Compasso	1		122
100100021	Compasso	1		1062
Classe 5				
Armadamento e munição				
Família 10				
100100022	Armadamento	1		1062
100100023	Armadamento	1		1062
Classe 6				
Pistola Semiautomática				
100100024	Pistola Semiautomática	1		1062
Classe 8				
Engenharia e cartografia				
Família 30				
100100025	Engenharia e cartografia	1		25
Classe 9				
Biossida Individual				
100100026	Biossida Individual	1		1062
Família 25				
100100027	Suprimento de Água	1		59
Classe 7				
Purificador de Água Individual				
100100028	Purificador de Água Individual	1		1062
Classe 2				
Tecnologia da Informação, Comunicação, Eletrônica e Informática				
Família 19				
100100029	Material Rádio de Campanha	1		*
100100030	Comparto Rádio - Grupo 2 Terrestre Portátil	1		*
Família 20				
100100031	Material de Informática de Campanha	1		*
Família 49				
100100032	Material Sateles de Campanha	1		*
Família 69				
100100033	Terminal Sateles Tx de Voz Portátil	1		*
Classe 9				
Tóxico				

Cia As Civ

Estrutura Organizacional

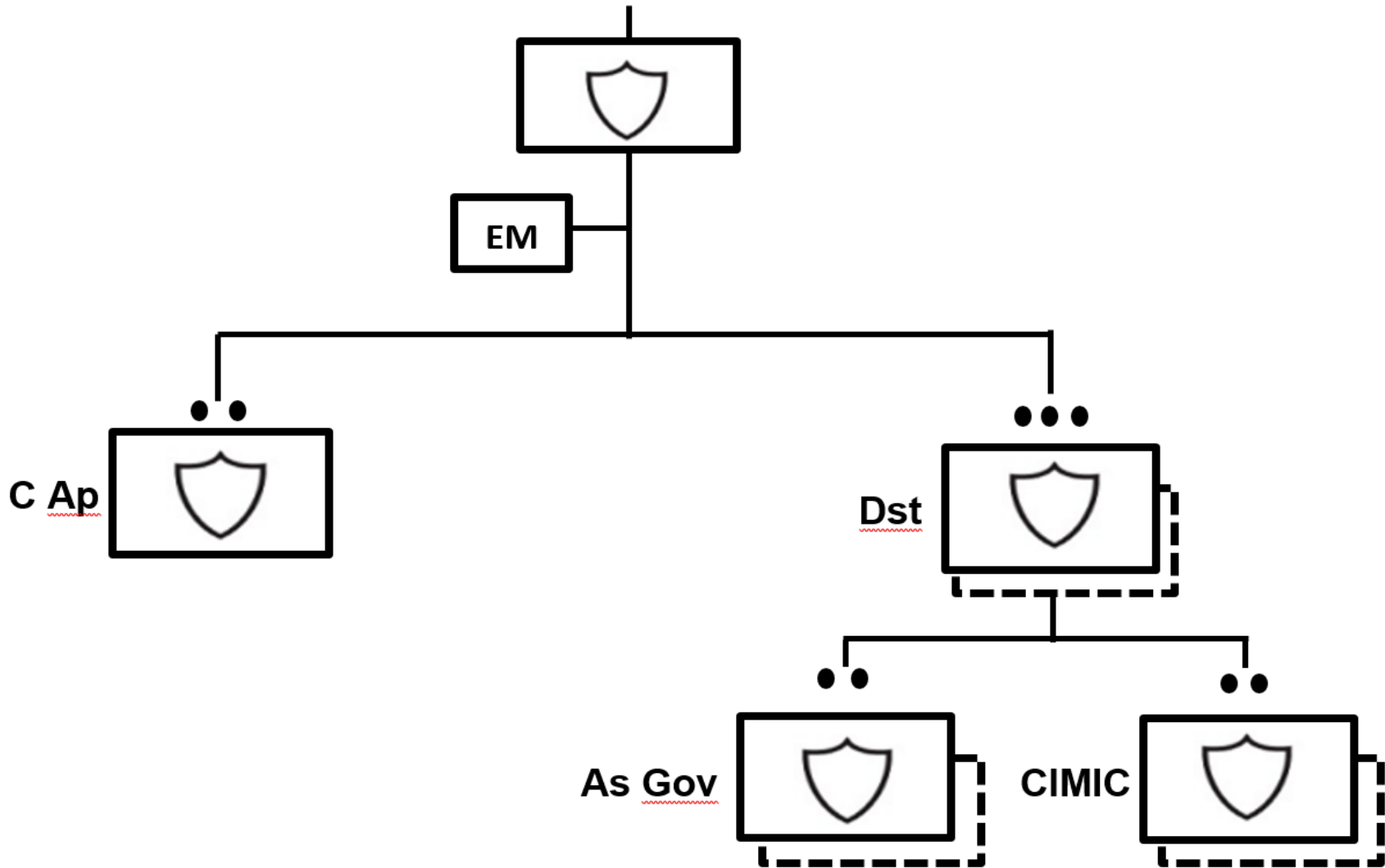

Assuntos Cívicos

(árvore de manuais)



2º Nível

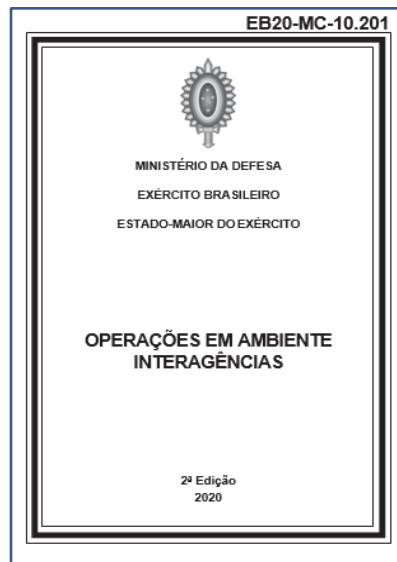

3º Nível



Perfil profissiográfico
Oficial As Civ

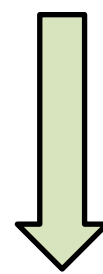
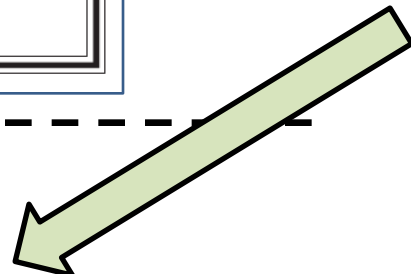

A group of people, including men and women, are sitting in a circle on the ground outdoors. They appear to be engaged in a community meeting or discussion. The background shows a simple outdoor setting with some structures and a vehicle. The image is overlaid with four dark blue text boxes containing white text.

Necessidades - Assuntos Cíveis

Criação de um estágio ou curso de Assuntos Cíveis

Criação de uma Cia As Civ

Elaboração de produtos doutrinários de 4º nível

Ações a realizar (COTER)



Chefia do Emprego

- 1. Acompanhar as modificações previstas na Expr Dout.**
- 2. Empregar a tropa de acordo com os novos produtos doutrinários de As Civ.**
- 3. Manter a Companhia de Assuntos Cíveis no QO da Operação Acolhida.**

Chefia do Preparo

- 1. Planejar a elaboração do PP Adestramento das frações de As Civ.**
- 2. Planejar a elaboração do caderno de instrução (CI) Táticas, Técnicas e Procedimentos de Assuntos Cíveis.**
- 3. Orientar os C Mil A para que conduzam o preparo, de acordo com os novos produtos doutrinários de As Civ.**

Ações a realizar (COTER)



C Dout Ex

- 1. Enviar proposta de QO ao EME.**
- 2. Elaborar e revisar os manuais previstos no PDDMT 2020 (Companhia de Assuntos Cíveis, Assuntos Cíveis e Operações em Ambiente Interagências).**
- 3. Acompanhar a fase de transição da Operação Acolhida (passagem de responsabilidades aos civis).**

Propostas (EME)



- 1. Aprovar o QO Cia As Civ.**
- 2. Estudar a possibilidade da criação de uma Companhia de Assuntos Civis na F Ter (PEEx 2024-2027).**
- 3. Em coordenação com o DECEx, estudar a possibilidade da criação de um curso ou estágio de As Civ.**

Propostas (DECEX)













- 1. Em coordenação com o EME, estudar a possibilidade da criação de um curso ou estágio de Assuntos Civis para capacitar pessoal da F Ter.**
- 2. Orientar os estabelecimentos de ensino para que utilizem os novos produtos doutrinários de As Civ.**





Análise - DOPEMAII

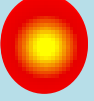
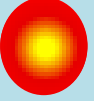
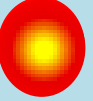
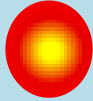
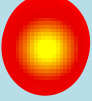
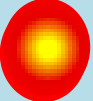
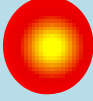
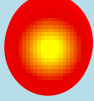

	FATORES / CAPACIDADE							
	D	O	P	E	M	A	I	I
Assuntos Cíveis 								
Assuntos Cíveis 								

Legenda

 80 a 100%

 50 a 80%

 Abaixo de 50%



Consequências da Expr Dout Cia As Civ

Desenvolvimento da doutrina de Assuntos Civis

Reflexos no Preparo e no Emprego

**Aumento das Capacidades Militares Terrestres
(CMT)**

“Apoio a Órgãos Governamentais”

“Comando e Controle”

“Superioridade de Informações”

“Interoperabilidade”

“Proteção”



Cel VALENÇA
C Dout Ex

EXPERIMENTAÇÃO DOUTRINÁRIA
COMPANHIA DE ASSUNTOS CIVIS